

✓ OK
✗ not OK

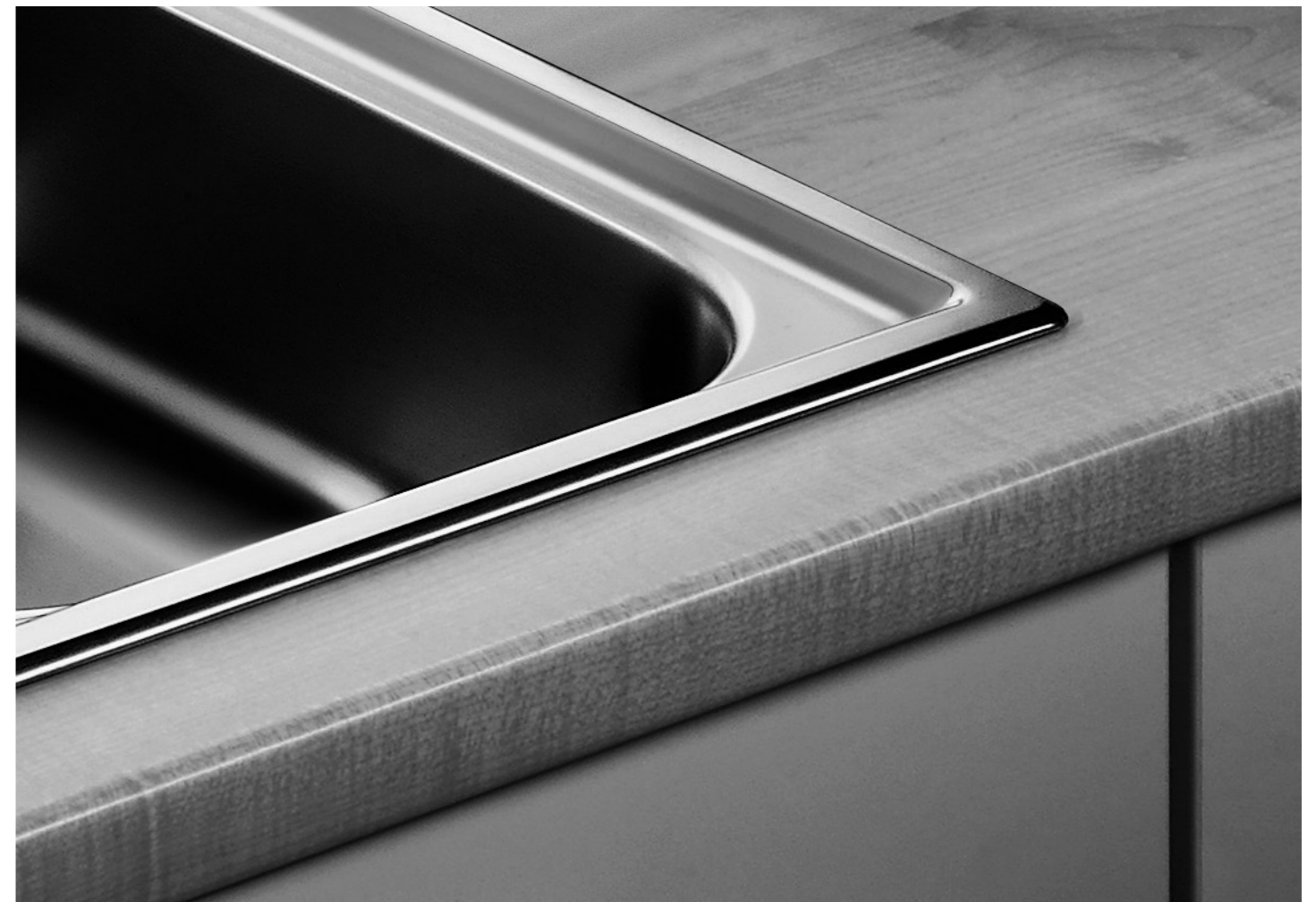

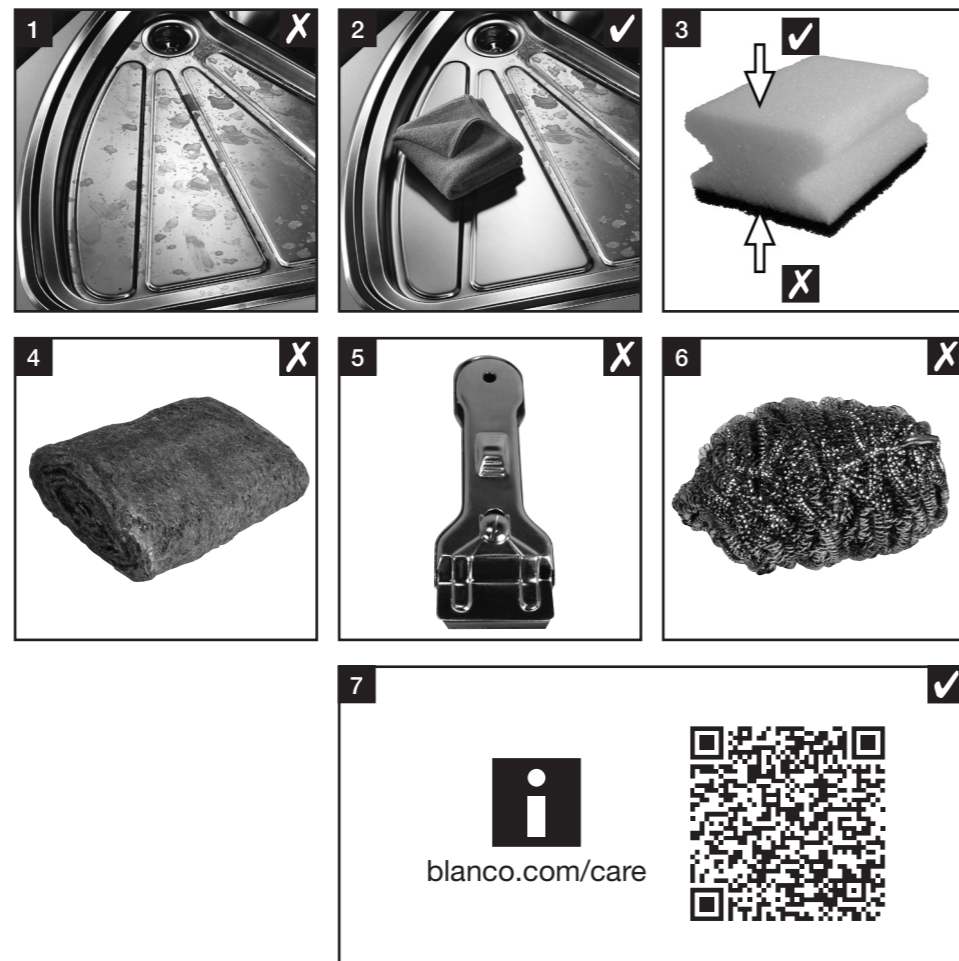

✓ OK
✗ not OK

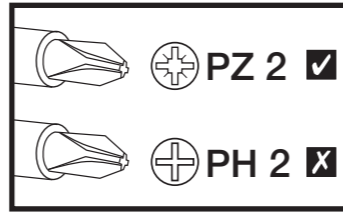
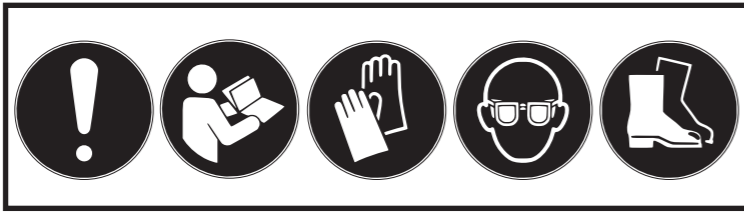
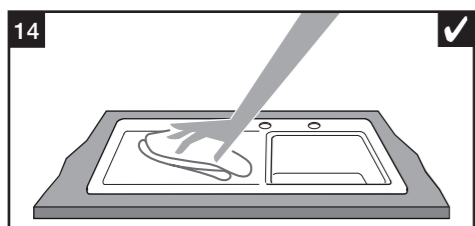
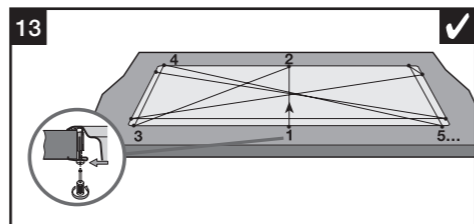
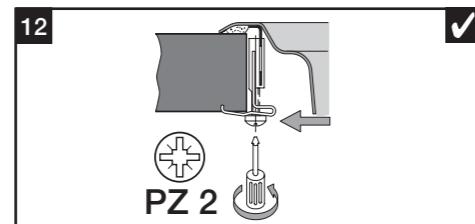
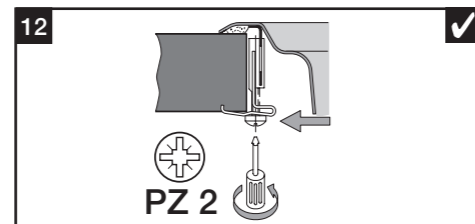
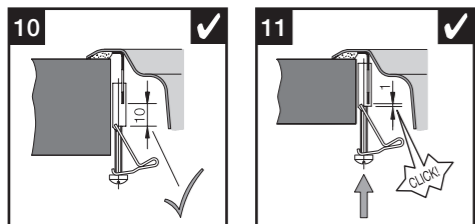
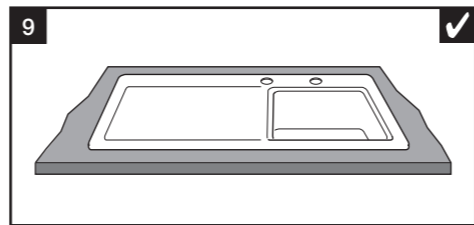
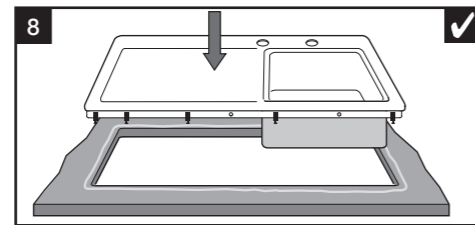
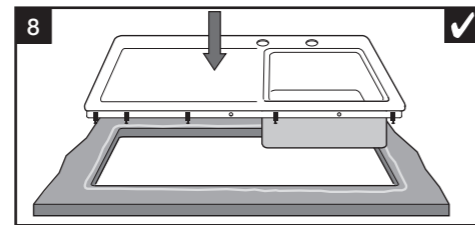
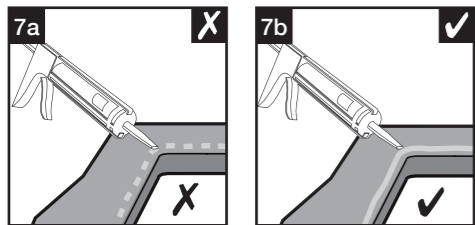
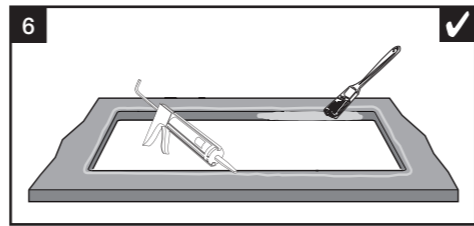
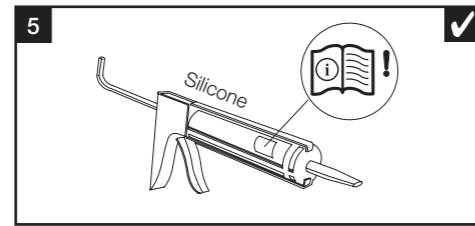
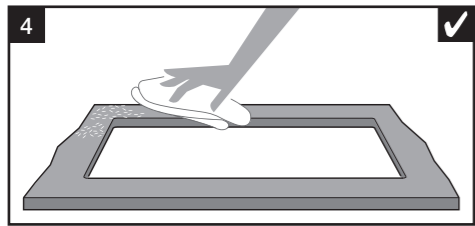
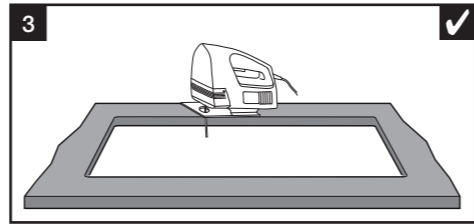
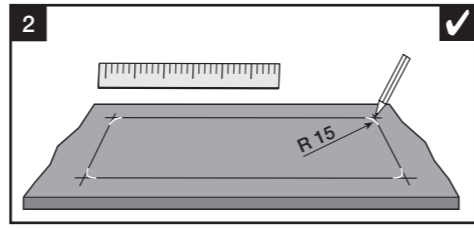
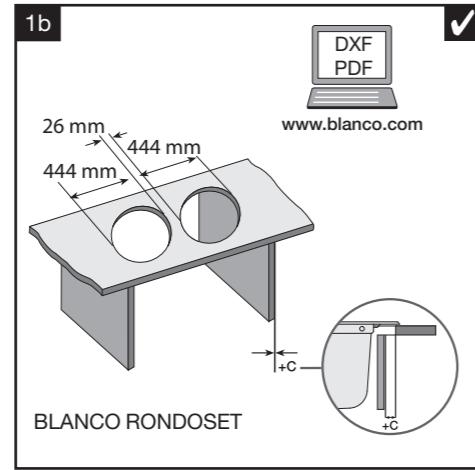
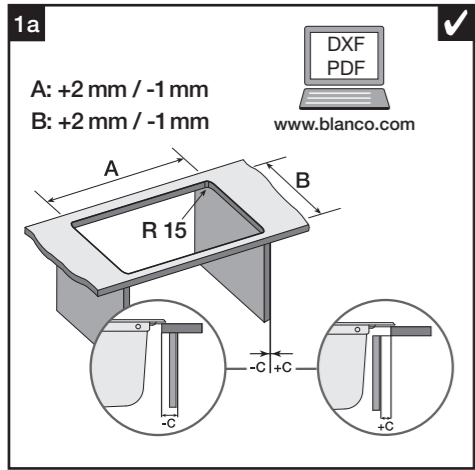

	+2mm / -1mm		
	A	B	C
BLANCO CLASSIC 40 S	762 mm	492 mm	-6,5 mm
BLANCO CLASSIC 8	762 mm	492 mm	-19 mm
BLANCO LANTOS 45 S	842 mm	482 mm	+10 mm
BLANCO LANTOS 5 S	932 mm	482 mm	+10 mm
BLANCO LANTOS 6 S	932 mm	482 mm	+4 mm
BLANCO LANIS 45 S	842 mm	482 mm	+10 mm
BLANCO LANIS 6 S	932 mm	482 mm	+9 mm
BLANCO LIVIT 45	462 mm	482 mm	+6 mm
BLANCO LIVIT 45 S	842 mm	482 mm	+16 mm
BLANCO LIVIT 45 S Salto	842 mm	482 mm	+7 mm
BLANCO LIVIT II 6 S	982 mm	482 mm	+8 mm
BLANCO LIVIT 6 S	982 mm	482 mm	+5 mm
BLANCO LIVIT 6 S Centric	982 mm	482 mm	+11 mm
BLANCO LIVIT 6 S Compact	762 mm	482 mm	+5 mm
BLANCO LIVIT 8 S	1192 mm	482 mm	-9 mm
BLANCO LIVIT XL 5 S	982 mm	482 mm	+11 mm
BLANCO LIVIT XL 6 S	982 mm	482 mm	+6 mm
BLANCO MAGNAT	842 mm	417 mm	-20 mm
BLANCO MEDIAN 45 S	840 mm	480 mm	+10 mm
BLANCO MEDIAN 6 S	980 mm	480 mm	+8 mm
BLANCO MEDIAN 8 S	1140 mm	480 mm	0 mm
BLANCO MEDIAN 9	840 mm	480 mm	-30 mm
BLANCO MEDIAN XL 6 S	980 mm	480 mm	+7 mm
BLANCO NAYA 9	842 mm	482 mm	-29 mm
BLANCO NAYA 9 S	1192 mm	482 mm	-29 mm
BLANCORONDO	Ø 444 mm	-	-3 mm
BLANCO RONDOSET	Ø 444 mm	-	+4,5mm (Bild1b)
BLANCO RONDOSOL	Ø 444 mm	-	-3 mm
BLANCO TIPO 45	462 mm	482 mm	+22 mm
BLANCO TIPO 45 S	842 mm	482 mm	+10 mm
BLANCO TIPO 45 S Compact	762 mm	482 mm	+10 mm
BLANCO TIPO 45 S Mini	587 mm	482 mm	+6 mm
BLANCO TIPO 5 S	932 mm	482 mm	+11,5 mm
BLANCO TIPO 6	587 mm	482 mm	-6 mm
BLANCO TIPO 6 Basic	587 mm	482 mm	-6 mm
BLANCO TIPO 6 S	932 mm	482 mm	-6 mm
BLANCO TIPO 6 S Basic	932 mm	482 mm	+9 mm
BLANCO TIPO 8	842 mm	482 mm	+21 mm
BLANCO TIPO 8 Compact	762 mm	482 mm	-19 mm
BLANCO TIPO 8 S	1192 mm	482 mm	-4 mm
BLANCO TIPO 8 S Compact	1140 mm	480 mm	-5 mm
BLANCO TIPO XL 6 S	932 mm	482 mm	-6 mm
BLANCO TIPO XL 9	932 mm	482 mm	+16 mm
BLANCO TIPO XL 9 S	1192 mm	482 mm	+16 mm
BLANCO TOP EE 5 x 5	483 mm	483 mm	+16,5 mm
BLANCO TOP EES 8 x 4	842 mm	417 mm	-4 mm
BLANCO TOP EES 10 x 5 / EES 10 x 5 II	962 mm	472 mm	+6 mm
BLANCO ZIA 45 S	842 mm	482 mm	+12 mm
BLANCO ZIA 5 S	932 mm	482 mm	+12 mm
BLANCO ZIA 6 S	932 mm	482 mm	+4 mm