

AIP-0018 / A1

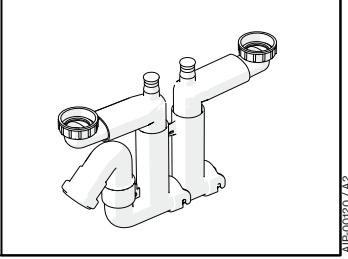

AIP-0018 / A2

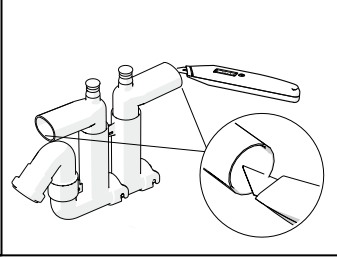
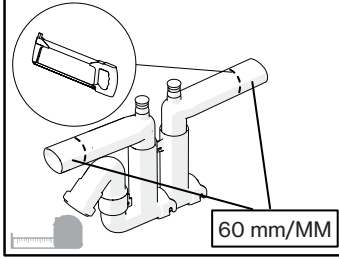
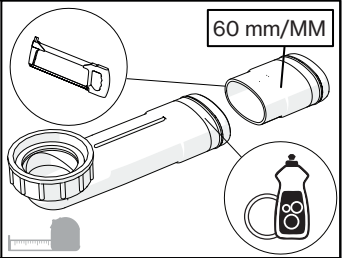
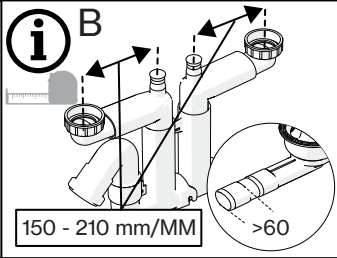
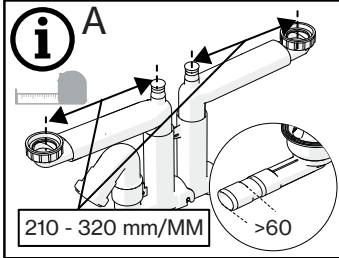
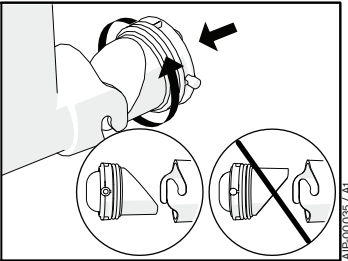
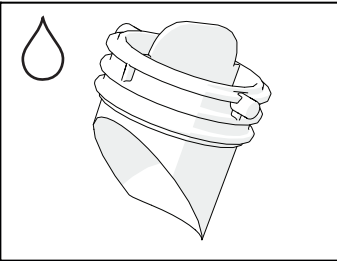
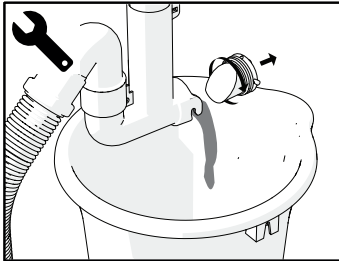

AIP-0018 / A3



OK!

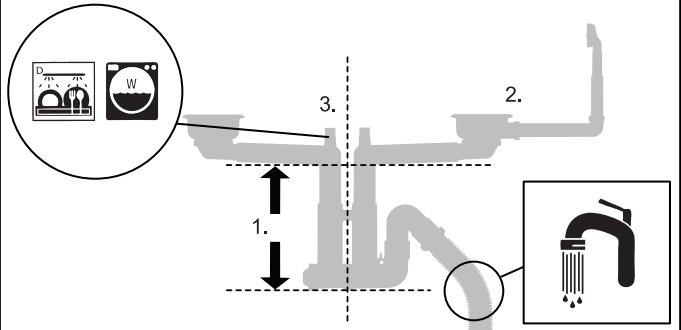

NOT OK!

